



Cover 2:
Sandro Olive

Cover 1:
Vento Hunter

Cover 3:
Bobby Mink

Inka Collection

Ultimate-Flex

Colours represented are to be used as a guide only.
Please refer to manufacturers swatch for a more accurate colour match.

Please note that colour shadings can vary slightly from each roll of fabric.
We cannot guarantee a precise match to these samples or between cut lengths and upholstered goods.

19/01/2023

INKA COVER GUIDE: STANDARD BACK ONLY

Please use this guide when ordering the following pieces to clarify cover options.

Corner Unit (COR)

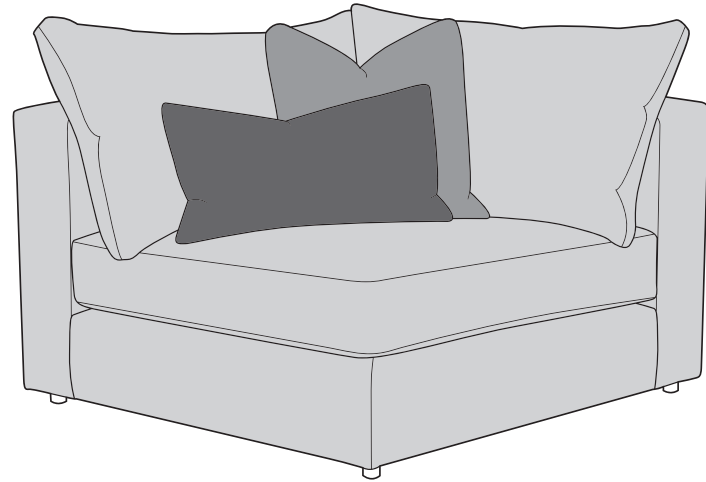

Armless Unit (AU)

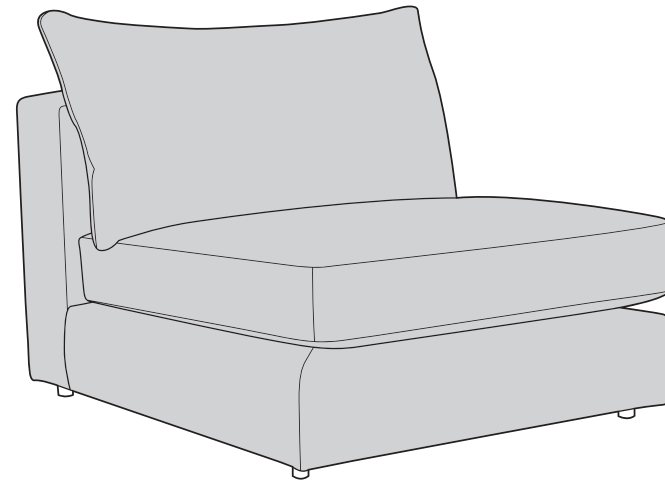

Footstool (FST)

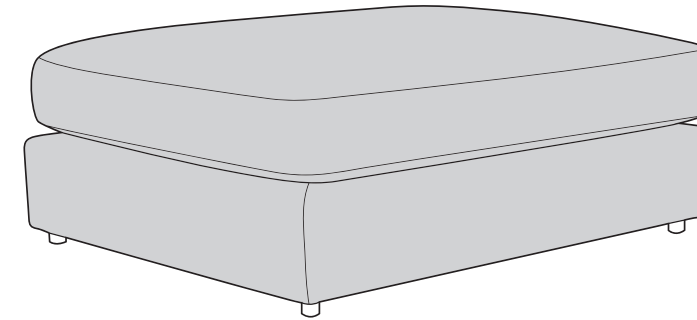

 **COVER 1**
(BODY)

 **COVER 2**
(SCATTER)

 **COVER 3**
(BOLSTER)

Scatter Cushions

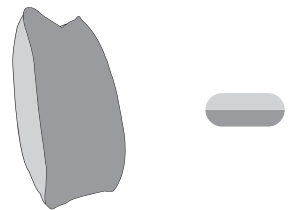

Front = Cover 2
Back = Cover 1

Bolster Cushion

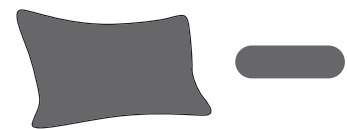

Front = Cover 3
Back = Cover 3

SUGGESTED CONFIGURATIONS

U Shape Corner Group:
COR, COR, ALU, ALU, COR, COR

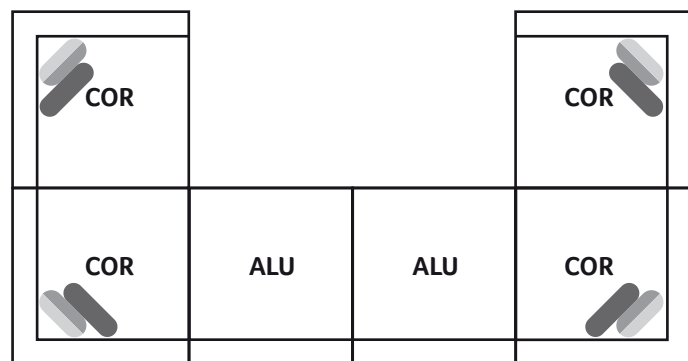

Large Corner Group:
COR, ALU, COR, ALU, COR

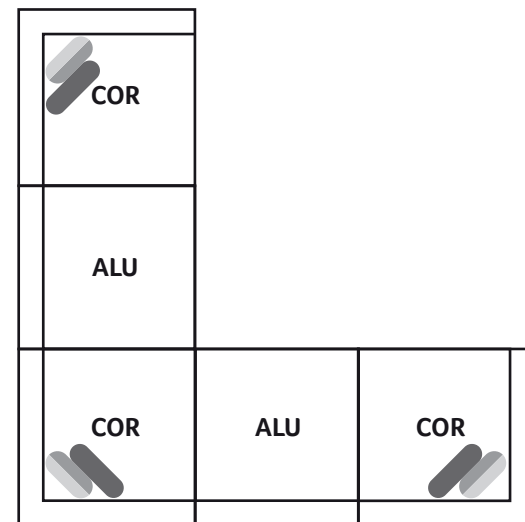

Chaise Corner Group:
COR, ALU, COR, ALU, FST

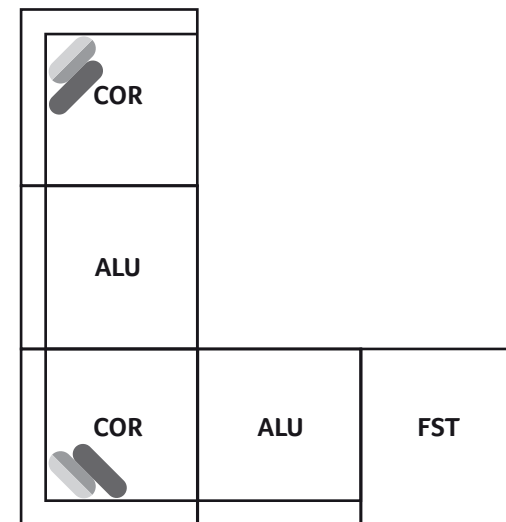

Chaise Sofa Group:
COR, ALU, COR, FST

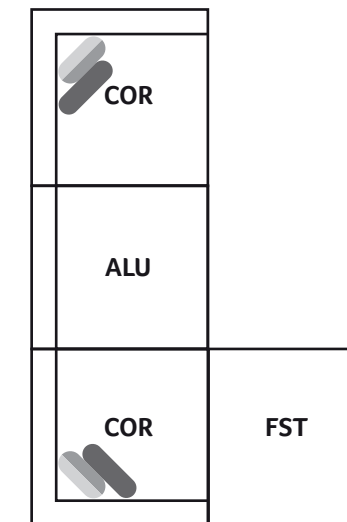

INKA DIMENSIONS (CM)

| AVAILABLE PIECES | HEIGHT 1 | OUTBACK HEIGHT | WIDTH 2 | DEPTH 3 | ARM HEIGHT | SEAT HEIGHT 4 | SEAT DEPTH 5 | SEAT WIDTH 6 | ACCESS DIAGONAL 7 | WEIGHT (KG) | SCATTER CUSHIONS |
|---|----------|----------------|---------|---------|------------|---------------|--------------|--------------|-------------------|-------------|-------------------------|
| CORNER UNIT (COR) | 89 | 69 | 115 | 115 | 69 | 44 | 67 | 67 | 158 | 48 | 1 SCATTER + 1 BOLSTER |
| ARMLESS UNIT (AU) | 89 | 69 | 96 | 115 | 69 | 44 | 67 | 96 | 145 | 33.5 | N/A |
| FOOTSTOOL (FST) | 44 | N/A | 96 | 115 | N/A | N/A | N/A | N/A | 145 | 21.5 | N/A |
| SUGGESTED CONFIGURATIONS | | | | | | | | | | | |
| U SHAPE CORNER GROUP: COR, COR, ALU, ALU, COR, COR | 89 | 69 | 422 | 230 | 69 | 44 | 67 | N/A | N/A | 259 | 4 SCATTERS + 4 BOLSTERS |
| LARGE CORNER GROUP: COR, ALU, COR, ALU, COR | 89 | 69 | 326 | 326 | 69 | 44 | 67 | N/A | N/A | 211 | 3 SCATTERS + 3 BOLSTERS |
| CHAISE CORNER GROUP: COR, ALU, COR, ALU, FST | 89 | 69 | 326 | 307 | 69 | 44 | 67 | N/A | N/A | 184.5 | 2 SCATTERS + 2 BOLSTERS |
| CHAISE SOFA GROUP: COR, ALU, COR, FST | 89 | 69 | 326 | 211 | 69 | 44 | 67 | N/A | N/A | 151 | 2 SCATTERS + 2 BOLSTERS |

* Hardwood & composite board frame.

* Feather filled backs for added comfort.

* Serpentine seat springs & silent wire.

* Dowelled, screwed, glued & stapled joinery.

* Reversible Ultimateflex seat interior.

* Elasticated back webbing.

* Sumptuous feather filled bolster and scatters included for added comfort.



DIMENSION GUIDE

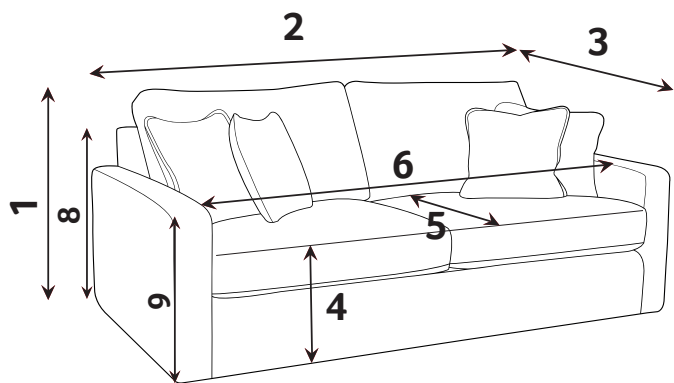

- 1 - HEIGHT
- 2 - WIDTH
- 3 - DEPTH
- 4 - SEAT HEIGHT
- 5 - SEAT DEPTH (STD & PILLOW)
- 6 - SEAT WIDTH
- 7 - DIAGONAL ACCESS
- 8 - OUTBACK HEIGHT
- 9 - ARM HEIGHT

Illustrations used for reference only.

Check the diagonal access dimension to ensure furniture will fit in your home.

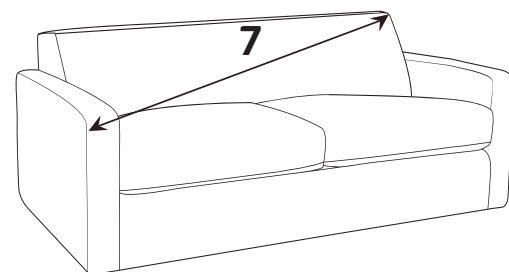

Ultimate-Flex

A high loft, high density foam inner seat interior surrounded by a dacron wrap that provides both comfort and support.

CARE GUIDE

Ultimate-Flex seat cushions should be plumped up on a regular basis to help maintain the aesthetic appeal of your upholstery, the plumping of cushions is essential to help retain the comfort and softness of any piece of upholstered furniture.

Ultimate-Flex seat cushions are fully reversible therefore to improve the longevity of your hand-made furniture, we recommend flipping cushions often.

For further information on maintaining your furniture please refer to the care guide located under the seat platform.

